

M12 male 0° / M12 male, 0°, shielded, Ethernet

PUR 2x2xAWG22 shielded vt UL,CSA+dragchain 12m

Ethernet CAT5e

Male straight – male straight

M12 – M12, 4-pole

D-coded

shielded

Further cable lengths on request.

Plastic housings with good resistance against chemicals and oils.

The resistance to aggressive media should be individually tested for your application. Further details on request.

Transmission properties with channel transmission up to 100 m

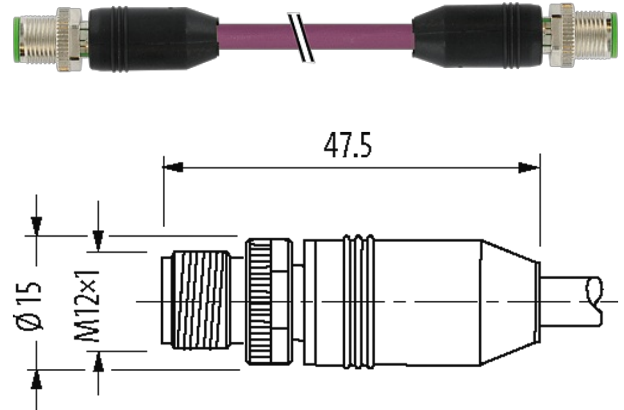
Illustration

Product may differ from Image

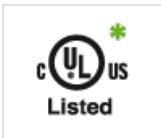
Approvals

* only for products with UL/CSA approved cable

cCSAus

More Info

EtherNet/IP



Form

Form 44511

Cables

No./diameter of wires	2 × 2 × 0.34 mm ²
Wire isolation	PO (wh, ye, bl, or)
C-track properties	3 Mio.
Material (jacket)	PUR (UL/CSA)
Outer Ø	6.7 mm ±5%
Bend radius (moving)	12 × outer Ø
Temperature range (fixed)	-40...+80 °C

Temperature range (mobile)	-30...+70 °C
Cable identification	798
Approval (cable)	UL (AWM-Style 20233/11602), CSA; CE
Cable weight [g/m]	68,64
Material (wire)	Cu wire, bare
Resistor (core)	max. 55 Ω/km (20 °C)
Single wire Ø (core)	0.15 mm
Construction (core)	19× 0.15 mm (multi-strand wire class 5)
Diameter (core)	2× 2× AWG22/7 (0.355)
AWG	similar to AWG 22
Material (wire isolation)	PO
Material property (wire isolation)	CFC-, halogen-, cadmium-, silicone- and lead-free
Wire-Ø incl. isolation	1.4 mm ±5%
Color/numbering of wires	wh, ye, bl, or
Shield	yes
	min. 80%
Material (jacket)	PUR
Material property (jacket)	CFC-, cadmium-, silicone- and lead-free, matt, low-adhesion, machine easy to process, abrasion-resistant
Shore hardness (jacket)	85 ±5 A
Outer-Ø (jacket)	6.7 mm ±5%
Color (jacket)	violet
chemical resistance	good resistance to oil, gasoline and chemicals
thermal resistance	flame retardant
Nominal voltage	300 V
Temperature range (fixed)	-40...+80 °C
Temperature range (mobile)	-30...+70 °C
Bend radius (fixed)	5× outer Ø
Bend radius (moving)	12× outer Ø
No. of bending cycles (C-track)	max. 3 Mio. (25 °C)
Traversing distance (C-track)	max. 5 m (horizontal)
Travel speed (C-track)	max. 3.3 m/s
Acceleration (C-track)	max. 2 m/s ²
Jacket Color	violet

Technical Data

Operating voltage	max. 60 V DC
Operating voltage (only UL listed)	max. 30 V DC
Rated surge voltage	1.5 kV
Operating current per contact	max. 4 A
Material group	IEC 60664-1, category I
Transfer parameters	CAT5e, Class D (ISO/IEC 11801:2002), (EN 50173-1)
Transfer rate	up to 100 Mbit/s full duplex
Coding	D-coded
Locking of ports	Screw thread (M12×1 mm) recommended torque 0.6 Nm, self-securing
Compression gland	M12 (SW13)
Protection	IP65, IP66K, IP67 inserted and tightened (EN 60529)
Locking material	Zinc die casting, matte nickel plated
Material	PUR
suitable for corrugated tube (internal Ø)	without

General data

Standards	DIN EN 61076-2-101 (M12)
Pollution Degree	3
Mounting method	inserted, tightened
Temperature range	-25...+85 °C, depending on cable quality

Commercial data

country of origin	DE
customs tariff number	85444290
EAN	4048879356732
eClass	27061801
Packaging unit	1

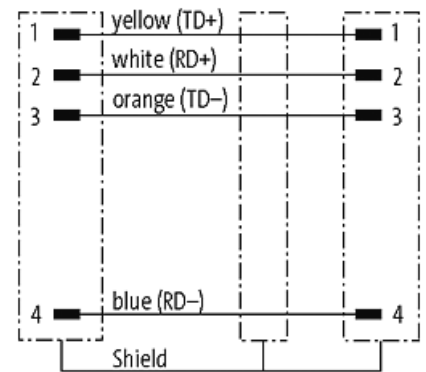
Sketch

Male

Male

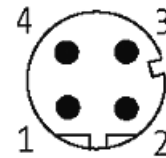

Product may differ from Image